

**Bareno**<sup>®</sup>  
— INSPIRED BY CLASS —

# MAGNETIC DISCHARGE

*Easy Installation, Easy Dismantle*



**PLUG & PLAY**  
Solve the Odor Problem from the Root



**STAINLESS STEEL  
LIFT RING**

Hidden lift ring design  
simplifies disassembly,  
cleaning & replacement.

**ABS UMBRELLA  
DESIGNED VALVE**

Excelled wear resistance &  
stability, optimised fluid  
flow design.

**TRI-POLE MAGNETIC  
CORE**

The durable and isolated  
magnetic field ensures  
a long-lasting and  
reliable product lifespan.

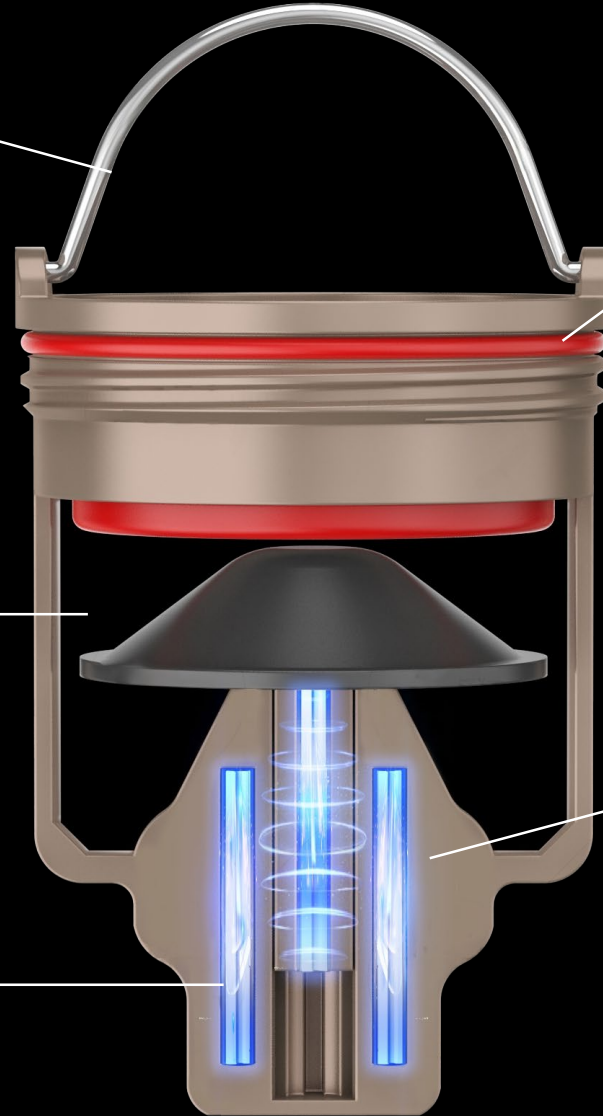

**ANTI OVERFLOW  
SILICONE SEAL RING**

Enhanced sealing effect  
for simpler installation &  
effective prevention  
of water overflow.

**FULLY COPPER-  
SEALED CASING**

Securely encloses the  
magnet within the casing  
to isolate magnetic fields,  
ensuring strong adhesion  
to objects.

# FEATURES

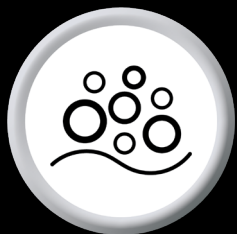

## Odor Free

Eliminate unpleasant smells.



## Backflow Prevention

Automatically allow water to flow in one direction while blocking reverse flow.



## Pest Shield

Help protect from harmful pesticides.

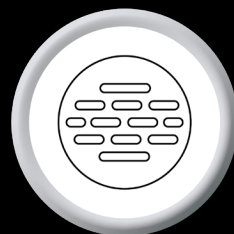

## Clog Prevention

Help maintain clear, functioning drains and reducing the need for costly repairs.

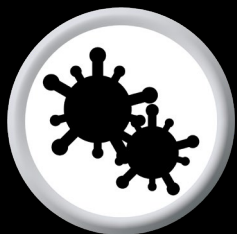

## Virus Defense

Minimizing infection risks.



## High Flow Capacity

Ensure efficient transport of the water to prevent bottlenecks.

# CHANNEL DRAIN



## BMC-1200

Material : *S/Steel 304*  
Size : *1,200 x 55 x 35mm*  
Thickness : *2.0mm*  
Finish : *Matt*  
Valve : *Brass H50mm*

## BMC-800

Material : *S/Steel 304*  
Size : *800 x 55 x 35mm*  
Thickness : *2.0mm*  
Finish : *Matt*  
Valve : *Brass H50mm*

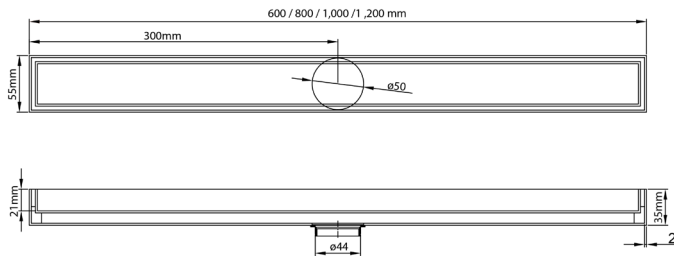

## BMC-1000

Material : *S/Steel 304*  
Size : *1,000 x 55 x 35mm*  
Thickness : *2.0mm*  
Finish : *Matt*  
Valve : *Brass H50mm*

## BMC-600

Material : *S/Steel 304*  
Size : *600 x 55 x 35mm*  
Thickness : *2.0mm*  
Finish : *Matt*  
Valve : *Brass H50mm*

## 3 IN 1 SIGNATURE HIDDEN DISCHARGE



Available in:  
 - Reversible cover  
 - Tiles insert  
 - Marble insert

### BMD-150

Material : *S/Steel 304*  
 Size : *150 X 150mm*  
 Thickness : *2.0mm*  
 Finish : *Matt*  
 Valve : *Brass H50mm*

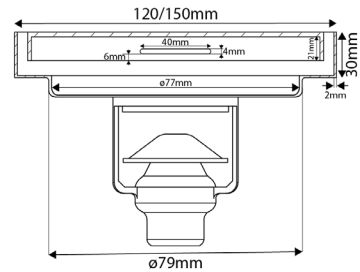

### BMD-120

Material : *S/Steel 304*  
 Size : *120 X 120mm*  
 Thickness : *2.0mm*  
 Finish : *Matt*  
 Valve : *Brass H50mm*

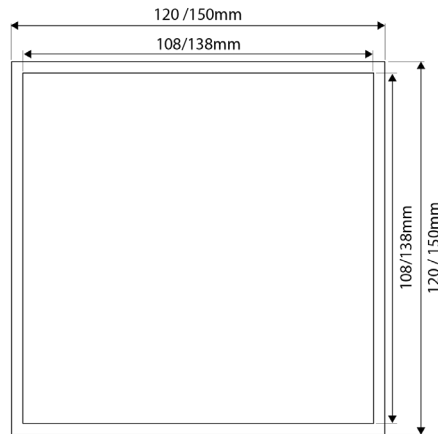

## LINEAR WATERFALL DISCHARGE

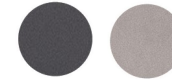

### BMD-LN150-BGM

Material : *S/Steel 304*  
 Size : *150 X 150mm*  
 Thickness : *3.0mm*  
 Finish : *Brushed Gunmetal*  
 Valve : *Brass H50mm*

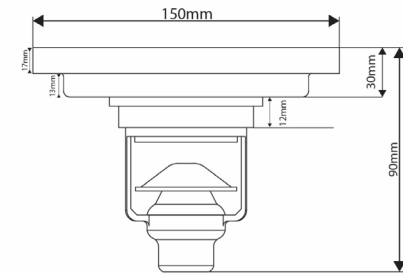

### BMD-LN150

Material : *S/Steel 304*  
 Size : *150 X 150mm*  
 Thickness : *3.0mm*  
 Finish : *Nickel*  
 Valve : *Brass H50mm*

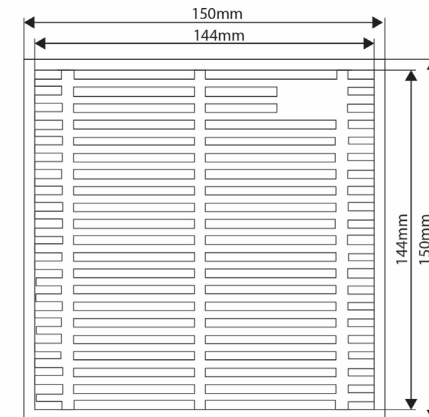

## LINE WATERFALL DISCHARGE



### BMD-L120-BGM/CP

Material : *Brass*  
 Size : *120 X 120mm*  
 Thickness : *3.8mm*  
 Finish : *Brushed Gunmetal, Chrome*  
 Valve : *Brass H50mm*

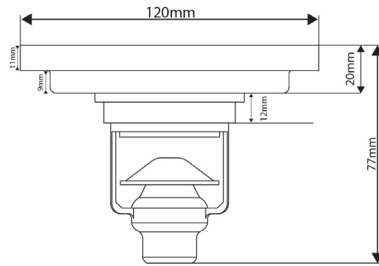

### BMD-L120

Material : *Brass*  
 Size : *120 X 120mm*  
 Thickness : *3.8mm*  
 Finish : *Nickel*  
 Valve : *Brass H50mm*

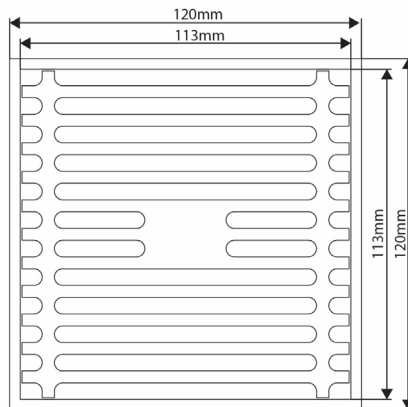

## SATURN WATERFALL DISCHARGE



### BMD-TM100-FGD/CP/BGM

Material : *Brass*  
 Size : *100 X 100mm*  
 Thickness : *4.0mm*  
 Finish : *French Gold, Chrome, Brushed Gunmetal*  
 Valve : *Brass H50mm*

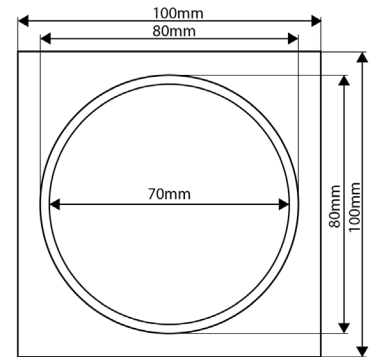
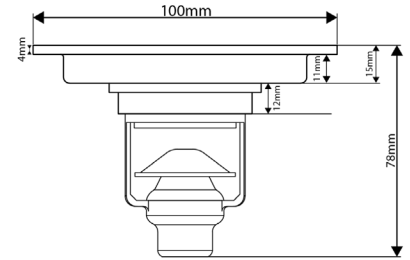

## SLEEVE WATERFALL DISCHARGE



### BMD-FR120-CP

Material : *Brass*  
Size : *120 X 120mm*  
Thickness : *4.0mm*  
Finish : *Chrome*  
Valve : *Brass H50m*

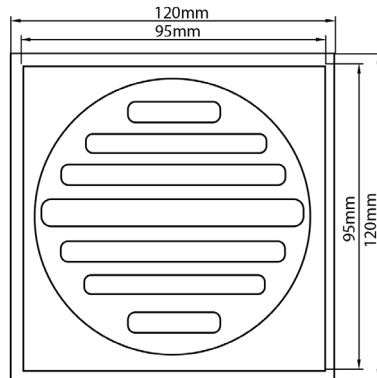
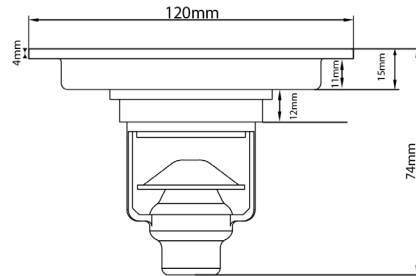

## WATERFALL DISCHARGE HIDDEN DRAIN

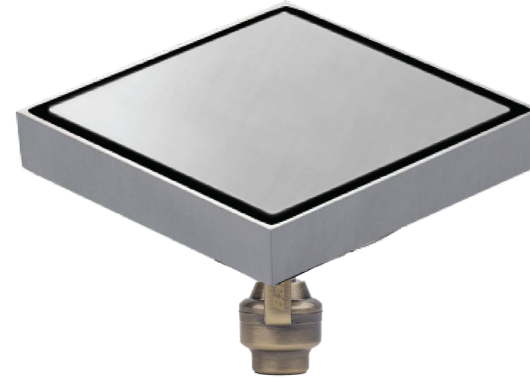

### BMD-9111

Material : *S/Steel 304 Tray, ABS Collar Frame*  
Size : *130 X 130mm*  
Thickness : *0.8mm*  
Finish : *S/Steel 304 Matt*  
Valve : *Brass H67mm*

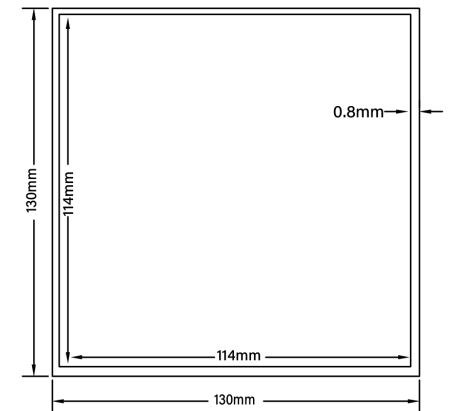
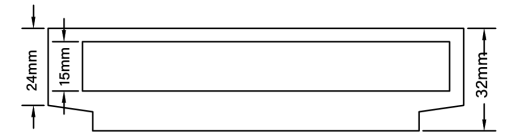

# WASHING MACHINE DISCHARGE VALVE



## BMD-FRS120-CP

Material : *Brass*  
Size : *120 X 120mm*  
Thickness : *4.0mm*  
Finish : *Chrome*  
Valve : *Brass H50mm*

## BD-FRS120-CP

Material : *Brass*  
Size : *120 X 120mm*  
Thickness : *4.0mm*  
Finish : *Chrome*

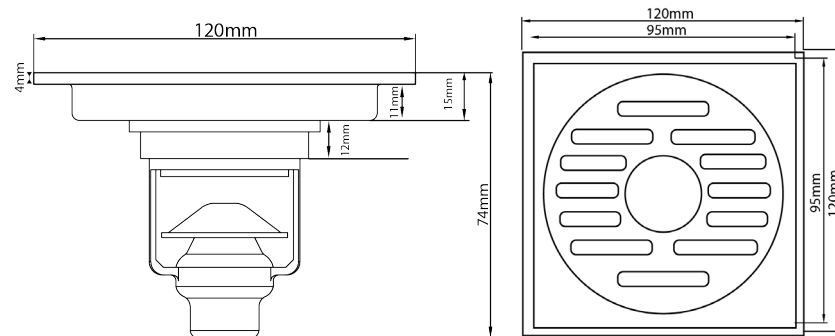

## WMV-TJ02

Material : *Brass Chrome*



## WMV-01

Material : *Brass Chrome*

# YOUR BATHROOM SOLUTION

## MAGNETIC FLEXI SET



### BMD-FS127

Material : *PP*  
Plate Size : *ø50-100mm*  
Valve : *Brass 127mm*

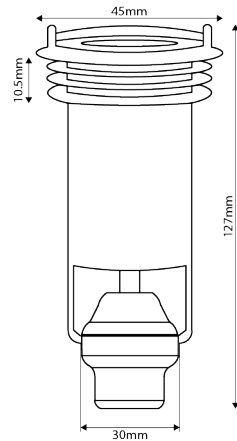

### BMD-FS67

Material : *PP*  
Plate Size : *ø50-100mm*  
Valve : *Brass 67mm*

